



MINI QUANTUM - PRO
Photocatalytic Pool Sanitiser
Installation & Operating Manual
QP-35



CONTENTS

1. IMPORTANT SAFETY INSTRUCTIONS	3
2. PRODUCT OVERVIEW	3
3. GENERAL INSTALLATION INSTRUCTION	5
3.1 Mounting instructions.....	5
3.2 Pipe work.....	5
3.3 Flow direction	6
3.4 Connection	7
3.5 Electrical connection.....	8
4. OPERATING INSTRUCTIONS	8
4.1 Flow requirements	8
4.2 Water quality.....	9
4.3 Lamp life indicator + intelligent dosing pump (Digital)	9
5. MAINTENANCE	14
5.1 Essential parts to carry out annual maintenance including our reference codes	14
5.2 Lamp replacement and quartz sleeve cleaning	15
5.3 Intelligent dosing pump routine maintenance	17
6. DISPOSAL OF ELECTRICAL/ELECTRONIC EQUIPMENT	18
7. WARRANTY	19
8. CALCULATING POOL VOLUMES	19

Introduction

Thank you for purchasing the Mini Quantum pool sanitising system, the latest sanitisation technology, manufactured to the highest standards in England.

To ensure years of trouble-free service, please **read and follow** these instructions for proper installation, maintenance and use. **Incorrect installation will affect your warranty.**

Please retain this manual for future reference.

1. IMPORTANT SAFETY INSTRUCTIONS

WARNINGS:

- Read the maintenance instructions before opening the appliance.
- Do not operate the ultraviolet-C emitter when it is removed from the appliance enclosure.
- Unintended use of the appliance or damage to the housing may result in the escape of dangerous ultraviolet-C radiation. ultraviolet-C radiation may, even in little doses, cause harm to the eyes and skin. This unit must be earthed.
- This unit must be earthed.
- Power must be supplied through a Residual Current Device (RCD) with a rated residual operating current not exceeding 30mA
- Do not run this unit dry
- Do not cover this unit
- The unit must not be submerged in water
- Carefully examine the unit after installation. It should not be powered on if there is water on any parts not intended to be wet
- If the unit shows any sign of water leakage immediately disconnect power supply
- If the quartz sleeve is cracked, replace it immediately
- To avoid injuries young children should never be allowed near UV steriliser
- Failure to disconnect the power from the UV steriliser and pump before servicing or maintenance could result in personal injury or property damage.

2. PRODUCT OVERVIEW

The Mini Quantum is available in 35W single tube format, supplied complete with flow switch and either an analogue lamp life indicator and reset switch, or digital lamp life countdown with intelligent dosing pump.

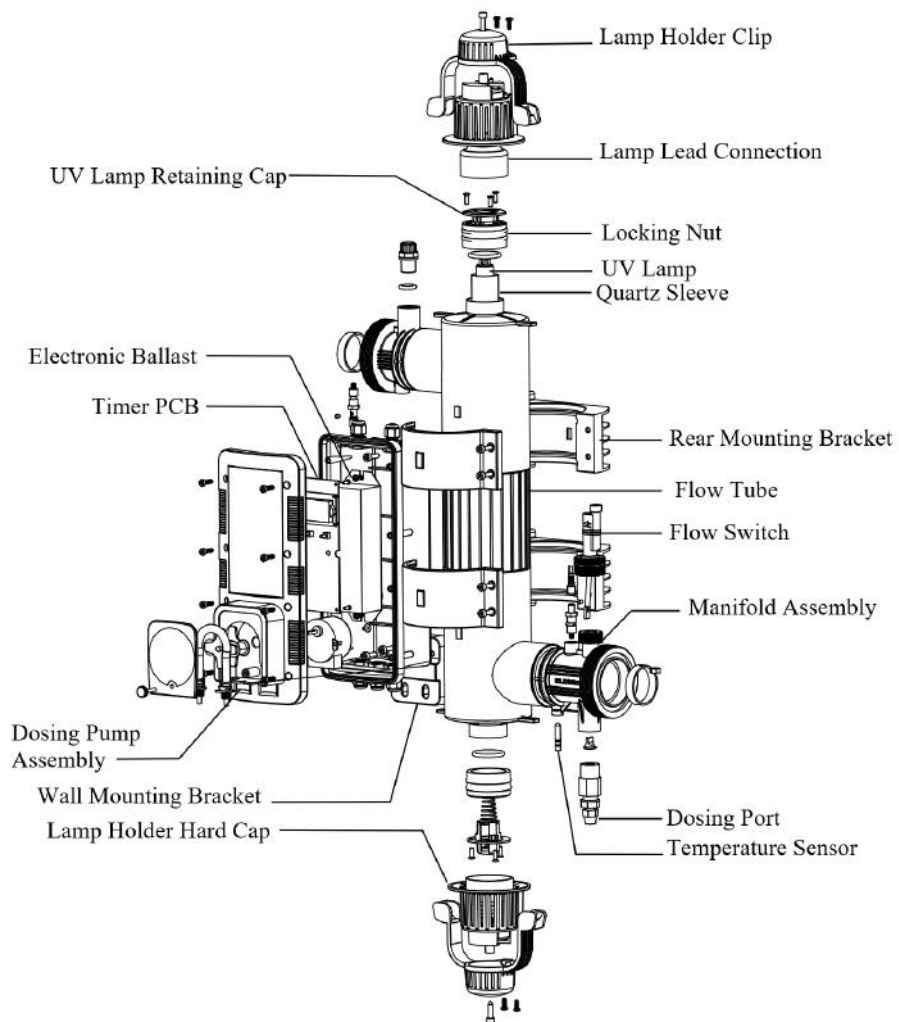

Fig. 1

Dimensions:

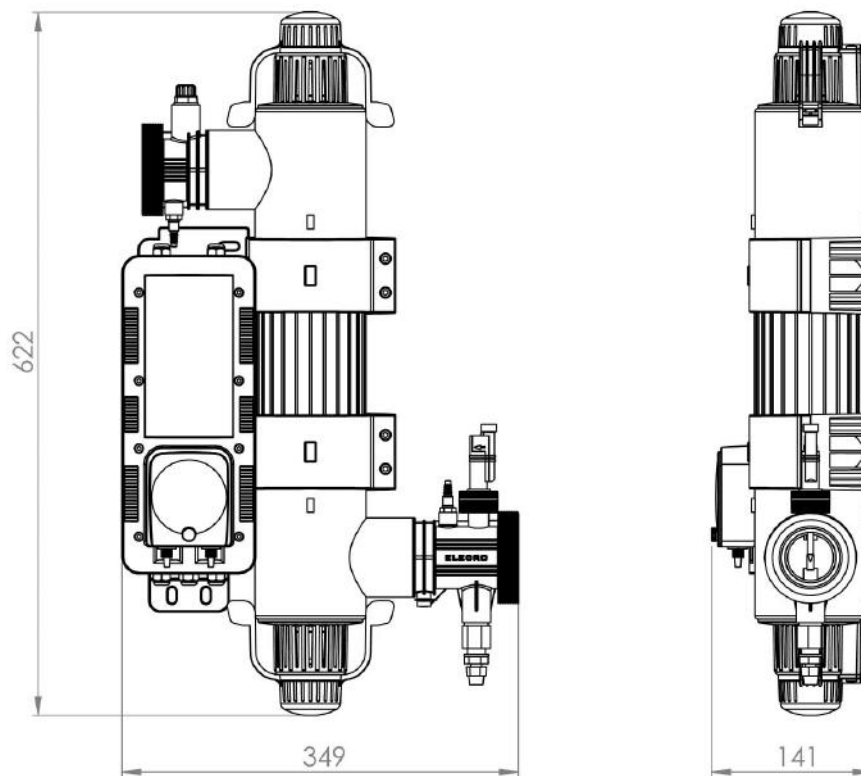

Fig. 2

3. GENERAL INSTALLATION INSTRUCTION

3.1 Mounting instructions

The Mini Quantum should be either installed horizontally or vertically allowing enough space for the pipe connections, wiring and maintenance of lamps/quartz sleeve. It should be firmly secured, using the fixing kit provided, to a solid wall.

NOTE: *When mounting the UV, it is essential to leave a clearance space of at least 1 metre from one side of the unit to allow access to replace the lamp(s) and/or quartz sleeve(s) when required. Both the lamps and the quartz sleeve can be replaced from either end of the unit; if installing vertically the 1m clearance space must be above or below the unit, if installing horizontally the 1m clearance space must be to the left or right of the unit.*

WARNING: The Mini Quantum must be installed within a dry, permanent weather-proof area. In any case where water or moisture enters the enclosure the warranty will be void.

Caution: *If the Mini Quantum is unused during the winter months, it **must be** drained to prevent frost damage. Water **must not** be allowed to freeze inside the unit as this will cause severe damage.*

See Fig. 3 for mounting instructions when securing to the wall.

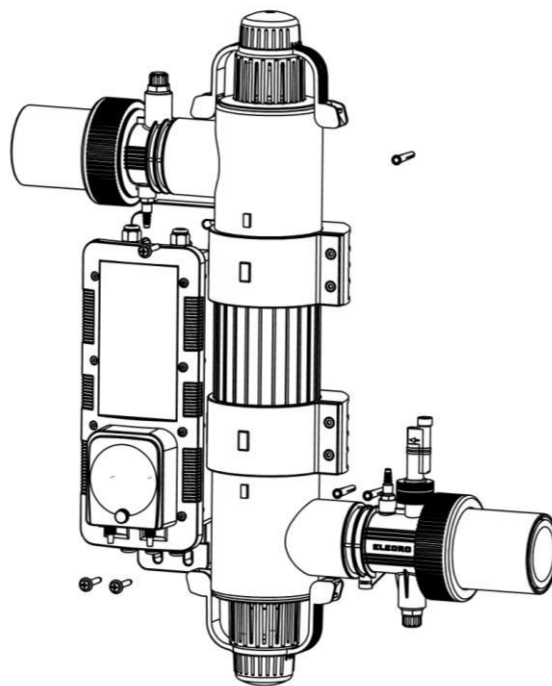

Fig. 3

3.2 Pipe work

The Mini Quantum should be placed downstream (after) of any pumps, filters and heating devices but upstream (before) of any chemical dosing or similar water treatment (see Figs. 4 and 5).

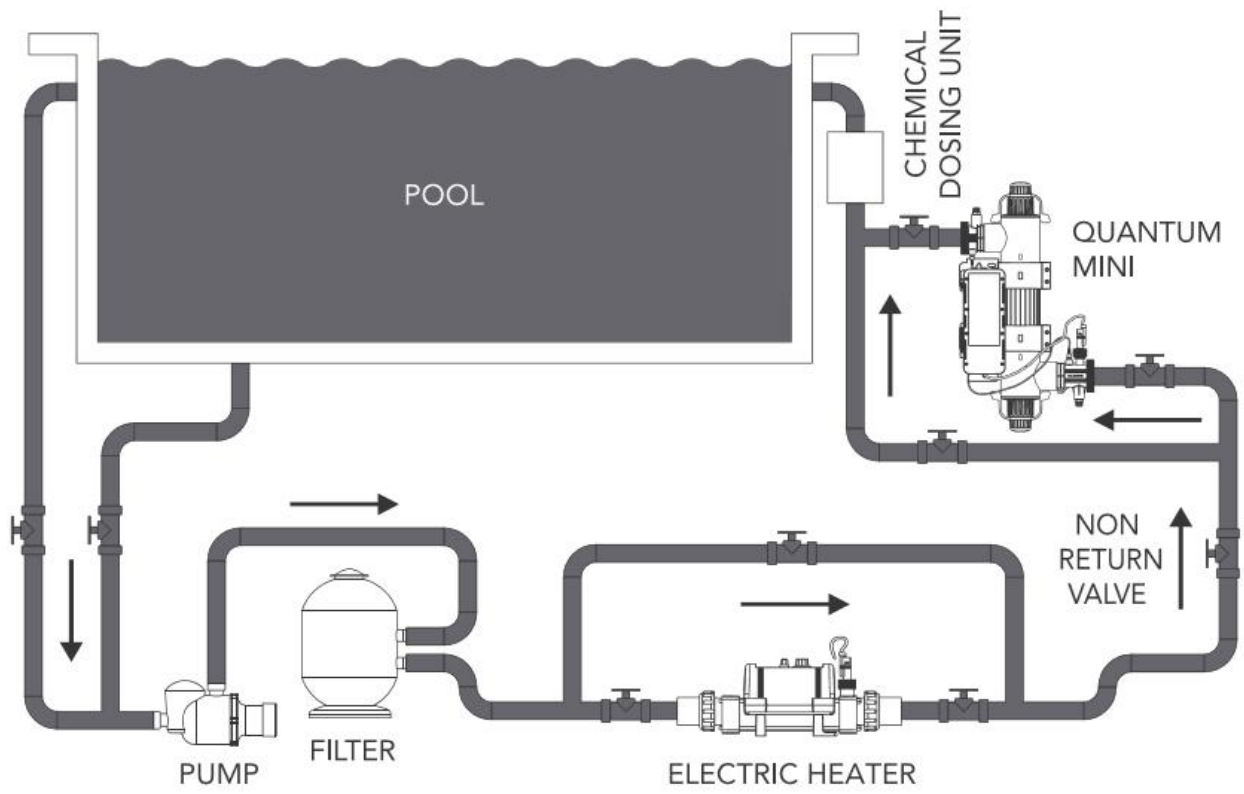

Fig. 4

3.3 Flow direction

The Mini Quantum is factory set to accept input water flow entering on the left and exiting on the right,

Vertical Mounting

Factory flow direction is left to right
 Optional reverse flow when vertical mounting

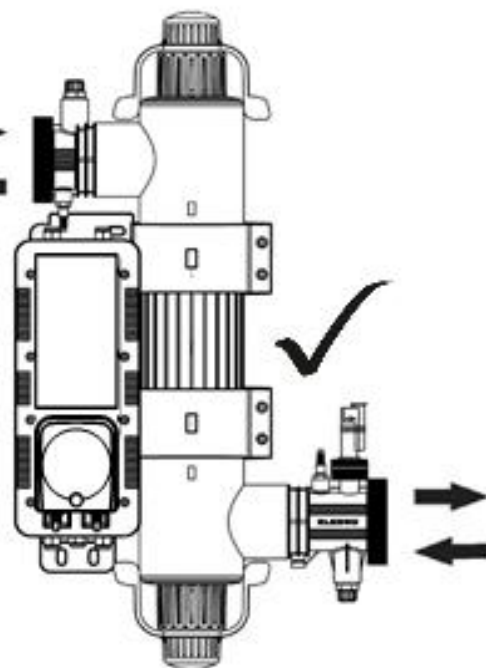

Horizontal Mounting

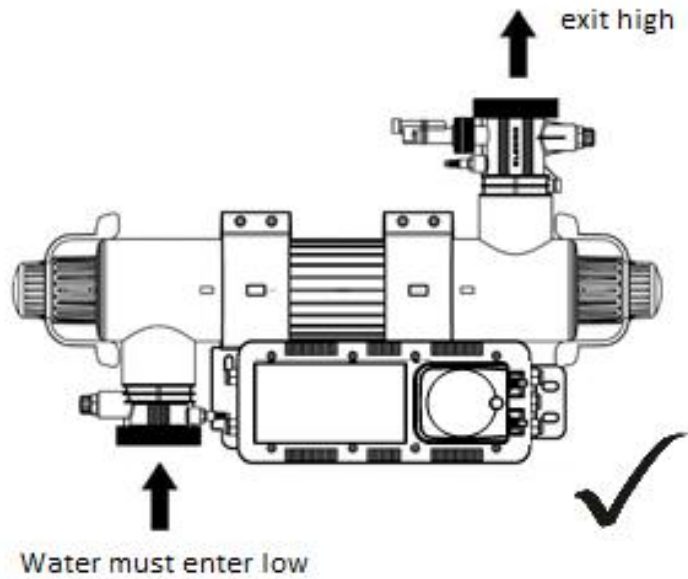

The Flow can be reversed by rotating the flow switch 180 degrees (i.e. ½ turn - see Fig. 6).

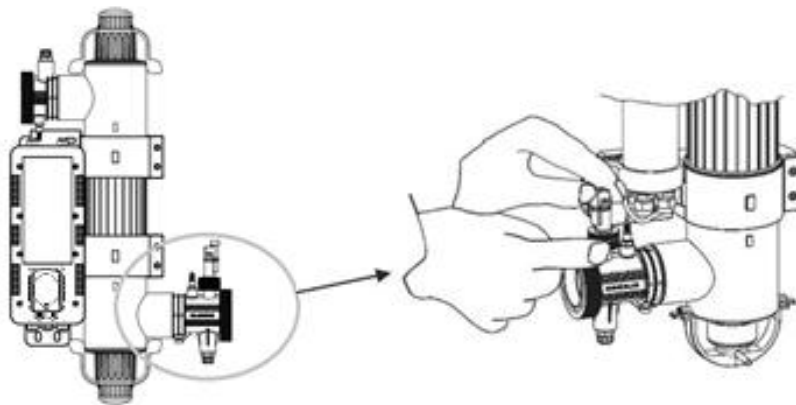

Fig. 6

WARNING! The flow switch paddle can be damaged when reversing the flow direction if it is lifted by more than 5mm from its housing and turned with force. If the flow switch has been rotated it is important to ensure that it is finally locked in the correct orientation perpendicular (at right angles) to the flow of water.

3.4 Connection

The unit is supplied with unions to allow connection to 2" or 63-mm rigid pipe. Reducers are also supplied to allow connection to 50-mm or 1½" rigid pipe - see Fig 7.

For pipework 63-mm or 2" in diameter.

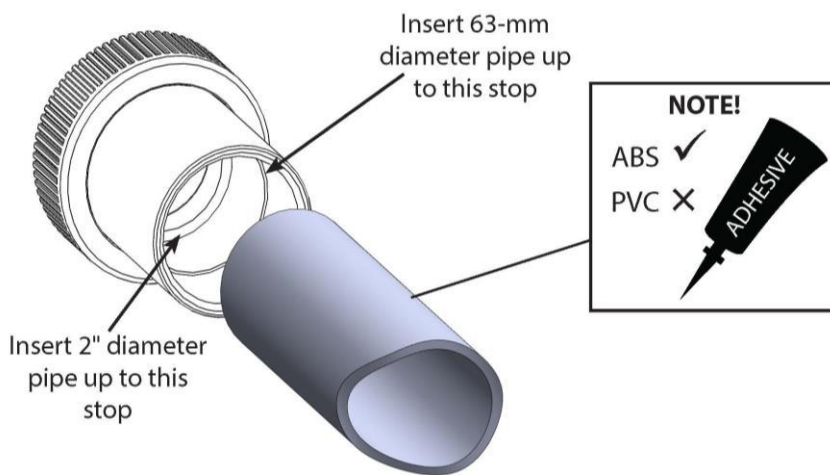

For pipework 50-mm or 1½" in diameter.

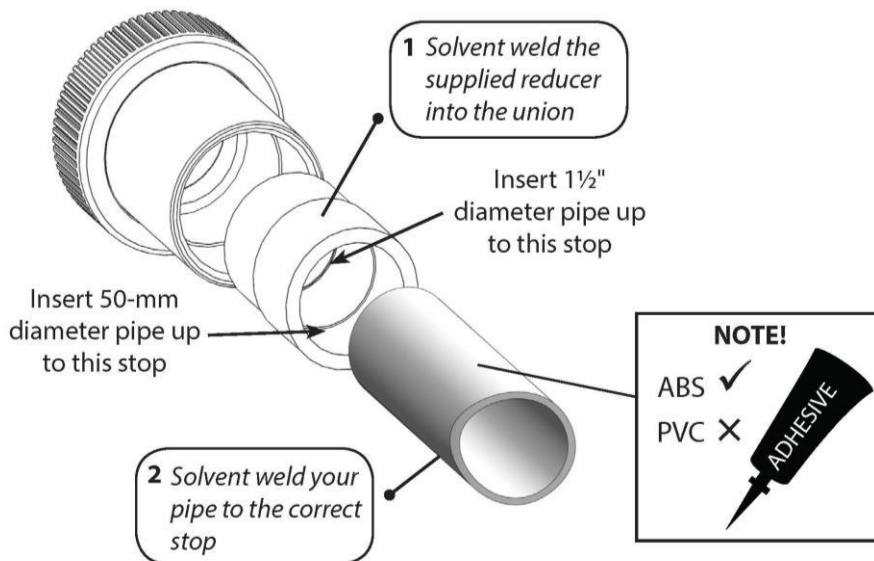

Fig.7

All factory unions are made from an ABS plastic, when gluing connections to an ABS pipe, an ABS cement must be used or when using a PVC pipe, a Transition cement must be used (See Fig. 7).

There is no need to use mastic or PTFE tape to connect unions to the Quantum, use the O-rings provided to put in the groove on the end of the Manifold Assembly.

3.5 Electrical connection

WARNINGS:

- This device must be installed by a qualified Electrician following the instructions provided in this manual. The manufacturer will not be liable for any issues caused by poor or improper installation.
- Any alterations made to the unit (unless stated) will affect the warranty. This also applies if components are changed for non-standard components acquired anywhere other than direct from the manufacturer.
- Incorrect installation may result in serious damage to property/persons.
- The Mini Quantum must be installed in accordance with the country/regional requirements and regulations and an Electrical Installation Certificate must be provided on completion of the installation.
- The power supply must be fitted with a 30mA RCD.
- Never look directly at an illuminated UV lamp.

4. OPERATING INSTRUCTIONS

4.1 Flow requirements

Minimum flow rate:

- 1m³/hour (1,000 litres per hour)

Maximum flow rate:

- 30W (Mini) = 12m³/hour (12,000 litres per hour)
- A higher flow rate will require the installation of a bypass to prevent damage to the unit.

This unit is a plug and play device so as long as the minimum flow rate is achieved the unit will work as soon as the power is switched on.

4.2 Water quality

The water quality MUST be within the following limits:

- PH: 6.8 – 8.0
- Total Alkalinity (TA): 80 – 140 ppm (parts per million)
- Chloride Content MAX: 150 mg/litre
- Free Chlorine: 2.0 mg/litre
- Total Bromine: Max 4.5 mg/litre
- Total Dissolved Solids (TDS)/Calcium hardness: 200 – 1,000 ppm

WARNING: Failure to meet the water quality limits will void the warranty.

4.3 Lamp life indicator + intelligent dosing pump (Digital)

How to connect the suction tube to the dosing pump:

This is how the completed assembly will look.

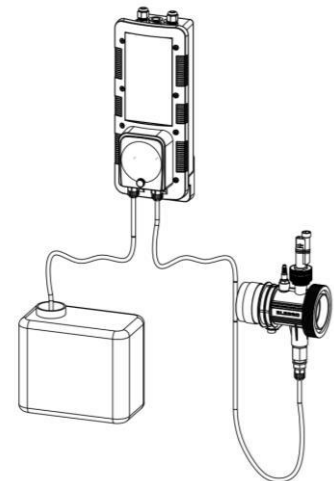

STEP ONE

Components required.

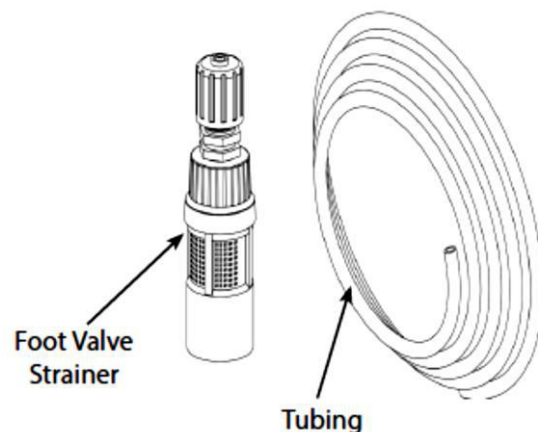

STEP TWO

Unscrew securing cap anti-clockwise.

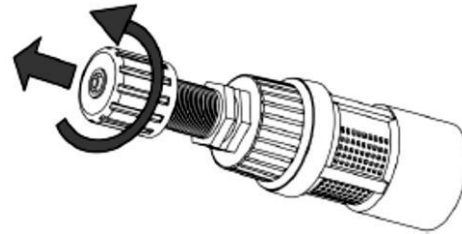

STEP THREE

Thread tube through the securing cap (1) and component (2), then push the pipe onto component (3)

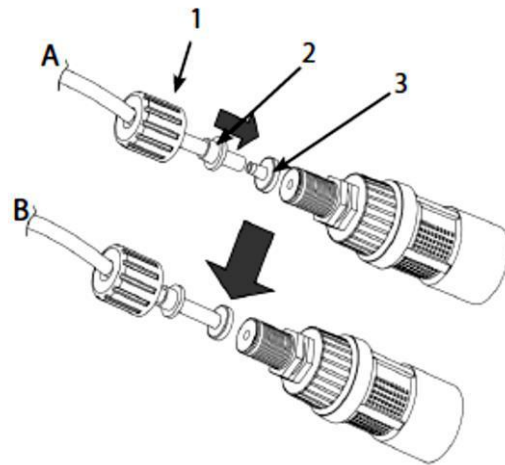

STEP FOUR

Once all components are looped through the tubing tighten securing cap.

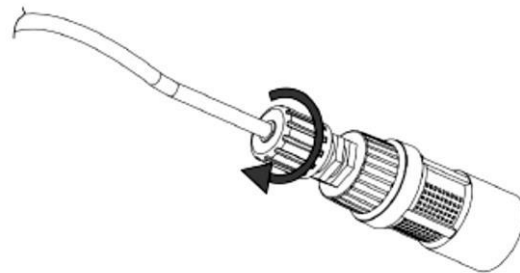

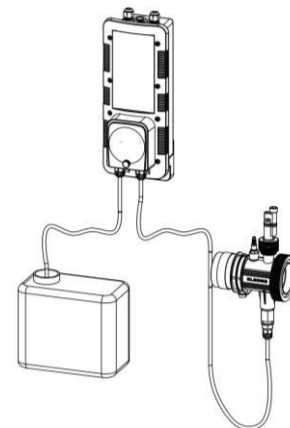

STEP FIVE

Lastly unscrew the retaining gland and insert tube over the connection point. Tighten the retaining gland Place the Foot Valve Strainer into the chemical container.



The language menu is displayed on each power up of the unit.

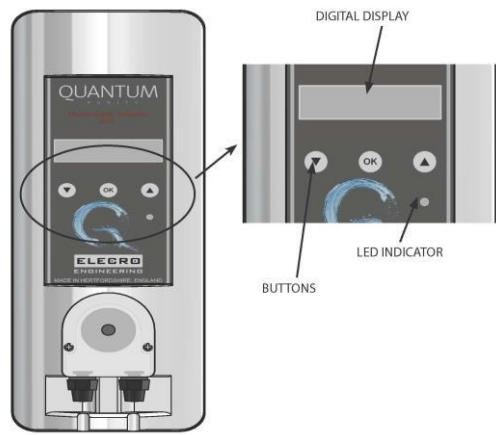

The factory default setting for the language is English.

To change to another language, press the  /  buttons until the desired language appears, press OK to select and save.



The digital controller has four programmable functions:

- UV Lamp Life
- Shock Dose
- Dose Chemical
- Set Time

To select a **mode**, press the  /  buttons until the desired mode is displayed then press the OK button to select that mode.



When the unit is powered on the UV lamp is switched on, the UV lamp will switch off under the following conditions i.e.

- Dosing pump 'On' (and for 30 minutes after the dosing pump has completed dosing)
- No or low water flow (the UV lamp(s) cannot be switched on unless the unit is receiving sufficient flow) See page 9 for flow requirements.

UV Lamp Life



LED Indicator

Whenever the UV lamp is 'On' a timer counts down from 14,000 hours and the remaining UV lamp life is displayed.

From 14,000 hours to 500 hours the LED in the control panel will light in green. When 499 hours is reached the LED colour will change to amber, when 0 hours are reached the LED light will change to red indicating that the lamp(s) must be changed.







When the UV lamp(s) are replaced the lamp life timer must be reset to 14,000 hours. In the UV lamp life mode select 'Reset UV Lamp' by pressing and releasing the O.K. button, then immediately press and hold the O.K. button until the display shows 'SAVED' then release the O.K. button, the display will then show 'UV Life 14,000 Hrs'. Please note power failure does not affect this lamp life countdown.

Chemical Dosing Set-Up

The controller is pre-programmed to dose two chemical types:



- A. Hydrogen Peroxide / Active Oxygen / H₂O₂
- B. Liquid Chlorine

To set the type of chemical: use the  /  buttons until "DOSE CHEMICAL" is displayed, press the O.K. button and then use the  /  buttons to choose:

- A. 'H2O2' or
- B. 'CHLORINE'

Press the O.K. button to select

A. Dosing Hydrogen Peroxide (H₂O₂)

After selecting 'H2O2' in Part 1 the display will now show 'H2O2 DOSE' the  /  buttons select the correct dosage volume in ml (millilitres) – Refer to Table A for suggested H₂O₂ dosing figures.

Once the correct dosage volume is displayed press the O.K button to confirm, the display will then show 'H2O2 START'

You now need to enter the time that you would like the dosing to take place.

NOTE:

- *The time must be entered in the 24-Hour format and the dosing will take place at this time every day (24-Hours).*
- *The time selected must be at a time when the main filtration pump will be running.*
- *Once the desired time has been selected press the 'O.K.' button and the display will then show 'SAVED'.*
- *If the dosing volume is set to 0.0 (ml) the peristaltic pump will remain off.*
- *In the event of power loss: the programmed settings (dosing volume and dosing time) will remain stored. If the power to the controller is switched off for longer than 3-Hours the current time will need to be re-programmed, this is indicated to the operator by the clock flashing.*

H₂O₂ Dosage Requirements

- Dosage amounts are set in ml/day (millilitres per day)
- Use the below reference table as a guide.
- To calculate your pool volume, see Pages 21-22 at the rear of this manual.

Volume of Swimming Pool (m ³)	Dosing Amount (ml/day)
35	200
50	320
60	420
80	620
90	700
100	800
130	1040
150	1200



Table A

NOTE:

- The above table is based on dosing Hydrogen Peroxide (H₂O₂) with a 32% concentration and a water temperature of 28°C.
- For a concentration of 12% the above dosing amount should be multiplied by 3 (i.e. the dose for a 50m³ pool would need to be increased to 960ml/day when the H₂O₂ strength is 12%).
- For any other concentration strengths, the dose amount should be adjusted pro-rata as required. The digital controller will automatically sense the temperature of your water and adjust the required dose accordingly.

B. Dosing Liquid Chlorine

- **TRICKLE DOSING:** When dosing liquid chlorine the required daily dosage amount will be split into multiple intervals within the filtration hours (for example, 420ml will be split into 20 smaller doses. Each dose will be injected for 32 seconds, and they will be equally spaced throughout a 6-hour period).
- If a power cut occurs during Trickle Dosing the unit will continue to dose the outstanding volume once the power has been restored. Please note - the volume that should have been dosed during the time of the power loss will be skipped.
- The controller does not monitor the free chlorine level. The pool free chlorine levels must be regularly checked, and the dosage volume adjusted if required.

After selecting 'CHLORINE' in Part 1 the display will show 'CL DOSE' using the  /  buttons select the correct dosage volume in ml (millilitres). Once the correct dosage volume is displayed press the O.K button to confirm, the display will then show 'CL START'

You now need to enter the time that you would like the CL dosing to take place. Once the correct time is selected press the 'O.K.' button.

NOTE:





- The time must be entered in the 24-Hour format and the dosing will take place at this time every day (24-Hours).
- The time selected must be at a time when the main filtration pump will be running.
- If the dosing volume for CL period is set to 0.0 (ml) the peristaltic pump will remain off.

Volume of swimming pool (m ³)	Dosing amount (ml/day)	Dosage is only approximate and dependant on the exact volume of your pool, local water type, temperature, positioning of the pool, bather loading, weather, etc.
10	200	
20	400	
30	600	
40	800	
50	1000	
60	1200	

Table B

NOTE: In the event of power loss: the programmed settings (dosing volume and dosing time) will remain stored. If the power to the controller is switched off for longer than 3-Hours the current time will need to be re-programmed, this is indicated to the operator by the clock flashing.



Set Current Time

- To complete the set up you need to programme the current time: Use the  /  buttons until 'SET TIME' is displayed, press the O.K. Button.
- Use the  /  buttons as required to select the current time
- **NOTE:** the time must be entered in the 24-Hour format.
- The display will now revert to showing the UV lamp life remaining and the current time.

Shock Dose

The shock dose feature enables the operator to shock dose the pool immediately with a chosen volume of the dispensing chemical. This may be necessary following heavy use of the pool or a change of water conditions.

To activate the Shock Dose feature uses the  /  buttons to scroll until 'SHOCK DOSE' is displayed, press the 'O.K' button.

Using the  /  buttons select the volume (in ml/millilitres) that you would like to shock dose the pool with. When the correct value is shown, press the 'OK' button to confirm. The display will show 'SAVED' and the shock dose will begin immediately.

NOTE: *The shock dose will only begin if the main filtration pump is operational.*

5. MAINTENANCE

To avoid any water leaks and optimum performance annual maintenance of the UV steriliser is essential. Failure to do so could result in damage to the product and significant drop in efficiency.

Annual maintenance includes:

- Changing of lamps(s) if necessary. Fig. 8.
- Inspection and cleaning of quartz sleeve. Replace if any cracks are discovered. Fig. 9.
- Replacing all O-rings. Fig. 10.
- Replacing lamp connectors (white plastic insert inside the blue bulb cap) if corroded, wet, damaged or overheated. Fig. 11.

5.1 Essential parts to carry out annual maintenance including our reference codes

WARNING: Before performing any maintenance isolate from the main power supply, turn off circulation pump and drain the unit.

SP-UV-LAMP-30



Fig. 8

SP-UV-QS-30



Fig. 9

SP-UV-ORS



Fig. 10

5.2 Lamp replacement and quartz sleeve cleaning

Removing the lamp and quartz sleeve



Unscrew all the highlighted fasteners



- Unclamping the clip from body
1. Pull the clip in shown direction to unlock from body
 2. Pull the second side after unlocking the 1st side



Remove Lamp holder Clip from Hard cap



Unmount the Hard cap from Blue lamp Holder



Carefully remove the blue lamp holder shroud and white plastic electrical end caps from the lamp end



Gently slide the lamp out ensuring that no pressure is applied to the glass quartz sleeve.



Unscrew the blue quartz sleeve locking nut anticlockwise. Both ends must be unscrewed before the quartz sleeve can be removed.



Slide the O-ring off the quartz sleeve



The quartz sleeve can now be removed.

Cleaning the quartz sleeve

Clean the sleeve and polish with a soft cloth or paper towel.

If you live in a hard water area there may be some limescale on the quartz sleeve. This can be easily removed by soaking the sleeve in a proprietary kettle descaling solution (follow the manufacturer's instructions).

NOTE: Failure to remove the limescale will limit the effectiveness of the UV lamp(s).

Assembly process

- Firstly, slide the clean dry quartz glass sleeve into the unit.
- Locate the 'O' rings carefully on the ends of the quartz sleeve.
- Make sure the threads are clean, wipe a little silicone grease onto the threads. As these threads are only serviced periodically, this lubrication will help to prevent them binding together.
- Hand tighten the blue quartz sleeve locking nuts onto the unit. Be sure not to overtighten as this can damage the quartz sleeve.
- Replace the UV lamp(s) with a new one(s) and reconnect blue lamp holders.

NOTE: To avoid bending the lamp pins during the reassembly, pull the plastic fitting out of the shroud. Connect it to the lamp and push the shroud back in to place.



NOTE: Pinch the blue lamp holder shroud as you reassemble the unit to release any trapped air. Failure to release the trapped air may cause the lamp holder to disconnect from the lamp end. Turn on the water supply to check for leaks **before** reconnecting the electric supply.

Important: The plastic body and blue compression fittings have been manufactured from polymers that have been specifically stabilised to protect them from the effects of the UVC emitted from the UV lamps. Despite this UV protection they will be eroded by a combination of the UVC and water flow. As a matter of course they should be inspected whenever a lamp change is carried out, to ensure they are not showing excessive wear and tear. Replacement parts are available.

5.3 Intelligent dosing pump routine maintenance

We recommend that the dosing tube is changed every 6-12 months in order to prevent any wear and tear and keep performance to an optimum. The following steps will guide you how to replace the dosing tube:

STEP ONE

Unscrew the two screws securing the plastic cover and remove. Rotate the grey connections caps to release the tubing.

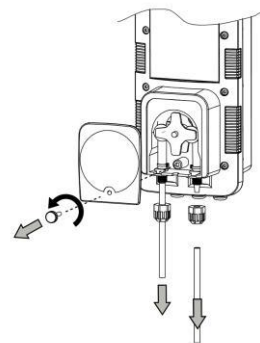

STEP TWO

Remove the connection point on the left-hand side, and then carefully manually rotate the cam to allow remove of the dosing tube.

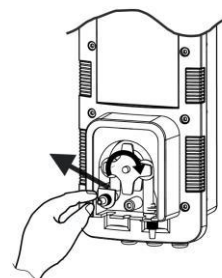

STEP THREE

Cut the two black securing ties at either end of the tube. This will then release the tube, which can be discarded.

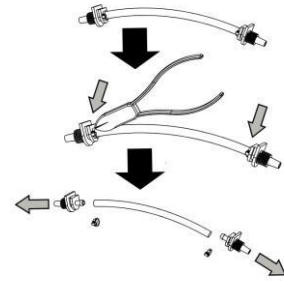

STEP FOUR

Take the replacement tube and re-attach connection points. Loop securing ties in place in order to seal to the connection points. Once securely in place cut the excess tie and dispose of.

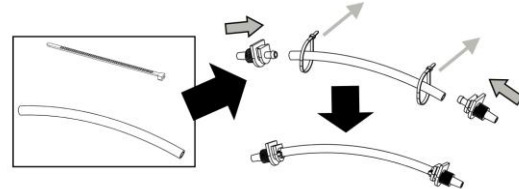

STEP FIVE

Place dosing tube into position on the left-hand side. Carefully rotate the cam clockwise, whilst feeding the pipe back into place.

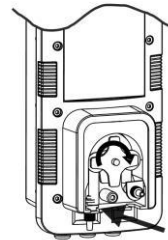

STEP SIX

Replace the suction and output tubes on to the connection caps and rotate to secure tubing back into place. Replace clear cover and screw into position.

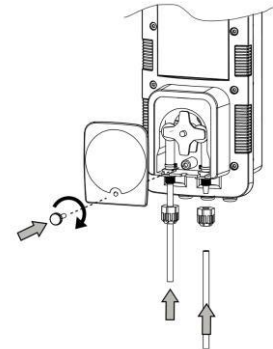

6. DISPOSAL OF ELECTRICAL/ELECTRONIC EQUIPMENT

DO NOT dispose of this product as an unsorted municipal waste.

This symbol on the product or on the packaging indicates that this product should not be treated as household waste. Instead it should be handed over to the applicable collection point for the recycling of electrical and electronic equipment.



By ensuring this product is disposed of correctly you will help prevent potential negative consequences for the environment and human health, which could otherwise be caused by inappropriate waste handling of this product. The recycling of materials will help to conserve natural resources.

For more information please contact your local Civic Office, household waste disposal service or the retailer where the product was purchased.

7. WARRANTY

This product is guaranteed from the date of purchase against faulty workmanship and materials for:

- **two years within Europe**
- **one year outside Europe**
- The manufacturer will replace or repair, at its discretion, any faulty units or components returned to the Company for inspection
- Proof of purchase may be required
- The manufacturer will not be liable in cases of incorrect installation of the heater, inappropriate use or neglect
- Any damages occurred due to shipping must be reported within 48 hours of receipt of the product. Any claims after this time will be considered as misuse or abuse of the product and will not be covered by the warranty.
- The guarantee does not include serviceable parts, i.e. lamps, quartz sleeves and O-rings, etc.

8. CALCULATING POOL VOLUMES

The following pages will show you how to calculate the volume of the pool.

NOTE: For pools with different depths:

$$\frac{D1 + D2}{2} = \text{Average Depth}$$

If your pool has a sloping bottom, then take the deepest measurement (D2) and the shallowest (D1). If there are different levels, then you need to do several calculations of area for each depth and add them up at the end.

Rectangle and Square Pools

Volume = Length (L) x Width (W) x Depth (D) or Average Depth

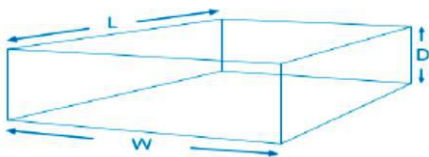

Circular

Volume = π (3.142) x Radius² x Depth (D) OR Average Depth

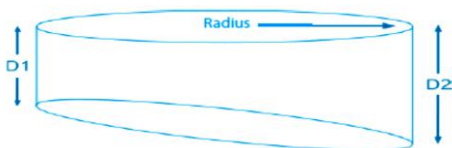

Radius = Diameter divided by 2

Ellipses

Volume = $\pi (3.142) \times A \times B \times \text{Depth (D)}$ OR Average Depth

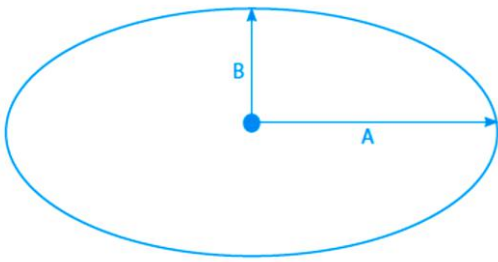

Irregular Shapes

For irregular shapes, calculating the area is less accurate. You will need to draw the pool accurately to scale on graph paper using one square on the graph paper to represent a metre (or foot) square of pool. When you have completed, count the squares.

For partial squares, count anything over half as one and ignore any under a half. When you have the area (A) multiply by depth (D) for the Volume in cubic metres. If you have several depths, break up your area calculation for each depth.

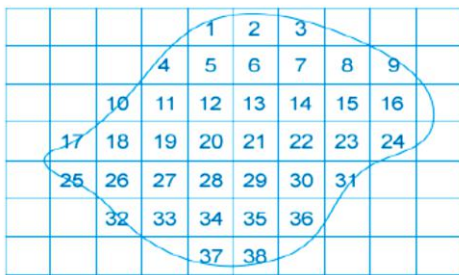

Useful Conversions

Cubic Metres to Litres = Multiply by 1000

Cubic Feet to Cubic Metres = Multiply by 0.0283168

UK Gallons to Litres = Multiply by 4.54609

Litres to Cubic Metres = Multiply by 0.001

Cubic Metres to UK Gallons = Multiply by 219.

**Electro Engineering Ltd
Repairs Department
Unit 11 Gunnels Wood Park
Gunnels Wood Road
Stevenage
Hertfordshire SG1 2BH
United Kingdom**

Customer Information: (ATTACH TO THE PRODUCT)

Company Name:

Contact Name:

Daytime Telephone Number:

Email Address:

.....

Return Address:

.....

Post/Zip Code:

Country:

Suspect Fault / Description of problem:



Unit 11, Gunnels Wood Park, Stevenage, Herts SG1 2BH
Sales@elecro.co.uk www.elecro.co.uk +44 (0) 1438 749474

© Copyright MANE166QP-EN-MINI QUANTUM PRO Manual V1-21.08.2021-Elecro