



Poolsmart PLUS Touchscreen Heating Controller Installation & Operating Manual



Contents

IMPORTANT NOTES	3
1. PRODUCT OVERVIEW	3
2. GENERAL INSTALLATION INSTRUCTION	4
2.1 Mounting instructions.....	4
2.2 Electrical connection.....	5
3. WIRING DIAGRAM	6
4. DIGITAL TOUCHSCREEN CONTROLLER OVERVIEW	7
5. OPERATING INSTRUCTION.....	7
6. INSTALLATION MODE	9
6.1 Language Setup	9
6.2 UNITS Setup	10
6.3 CLOCK Setup.....	11
6.4 TIMER Setup	11
6.5 Probe Calibration Setup	12
6.6 MODBUS Setup	13
6.7 FACTORY Setup.....	14
7. OPERATING MODES.....	14
7.1 Standby Operating Mode.....	14
7.2 Normal Operating Mode	15
7.3 Timer Mode	15
7.4 Priority of Heating Mode	16
7.5 Priority of Heating and Timer Mode	17
8. TROUBLE SHOOTING	17
9. DISPOSAL OF ELECTRICAL/ELECTRONIC EQUIPMENT	18
10. WARRANTY	18

IMPORTANT NOTES

Thank you for purchasing the Poolsmart Plus Touchscreen Heating Controller manufactured to the highest standards in England.

To ensure years of trouble-free service, please read and follow these instructions for proper installation, maintenance, and use. **Incorrect installation will affect your warranty.**

The appliance is not to be used by children or by people with reduced physical, sensory, or mental capabilities, or lack of experience and knowledge, unless they have been given supervision or instruction.

Please retain this manual for future reference.

1. PRODUCT OVERVIEW

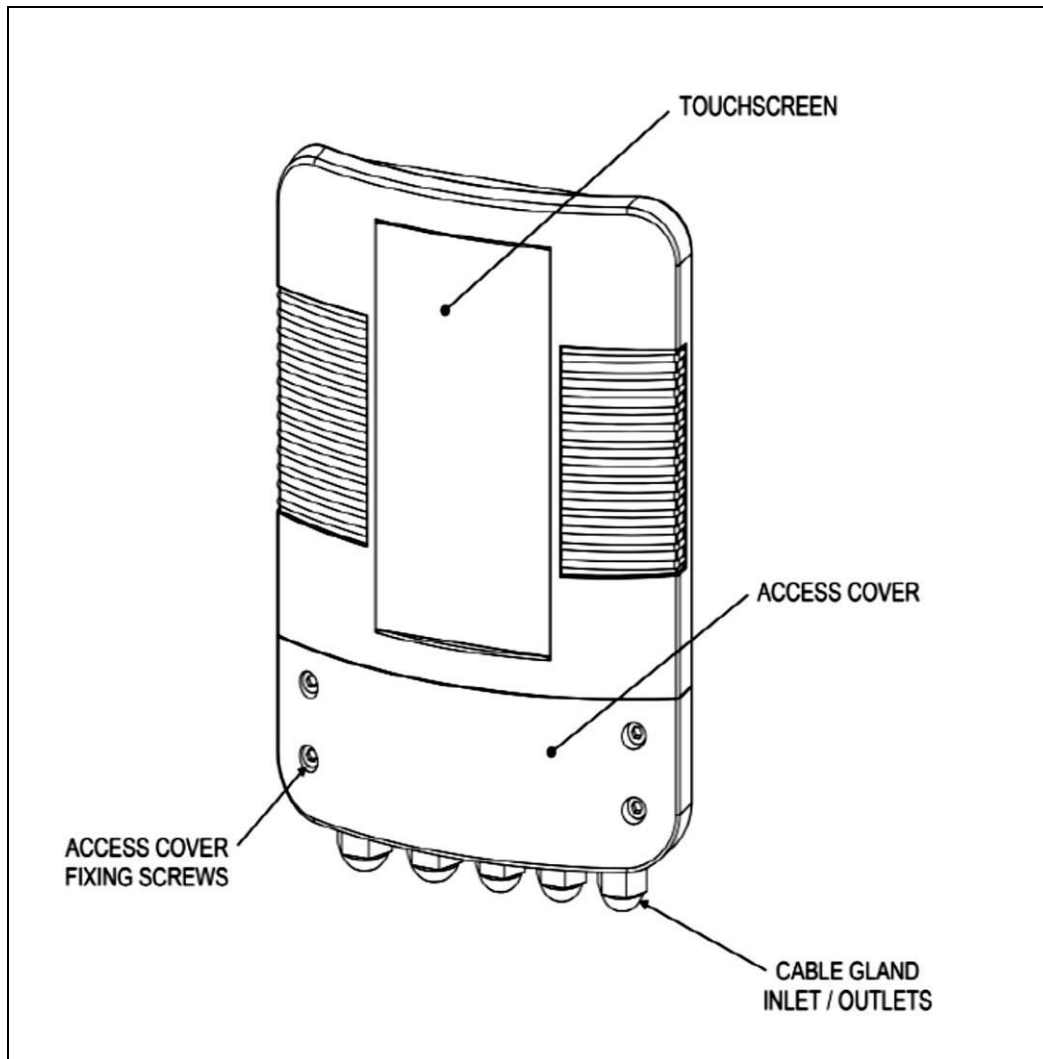

Fig 1.

2. GENERAL INSTALLATION INSTRUCTION

Screw mount the Poolsmart Plus to a suitable wall in a dry weatherproof location out of direct sunlight, ensuring that it is sited no more than 1 metre from the flow sensor and temperature sensor parts on your Electro heat exchanger.

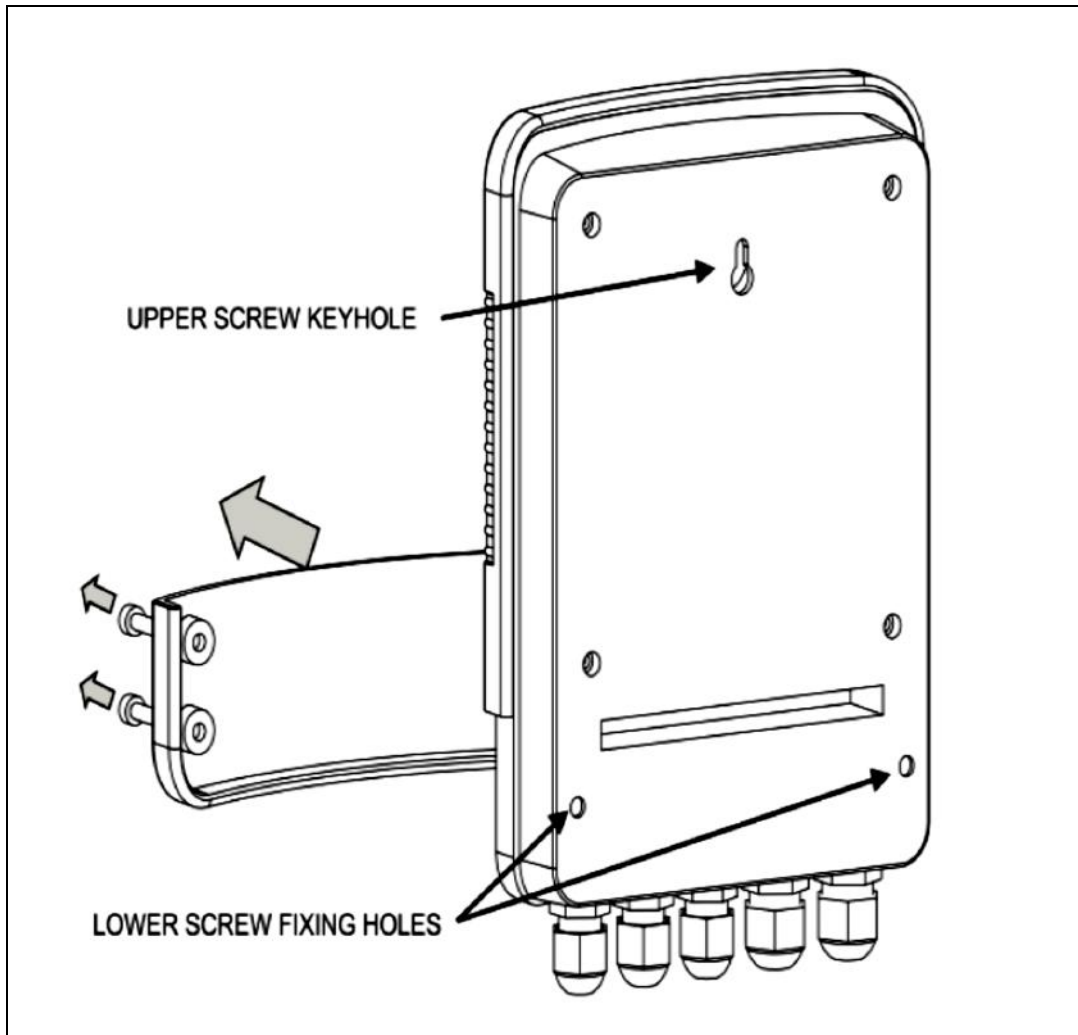

Fig 2.

The rear face of the Poolsmart Plus has an upper keyhole screw hook, located at the rear of the enclosure, and 2 lower screw holes which are accessed after removing the 4 screws retaining the lower access cover at the front.

2.1 Mounting instructions

The Electro G2 and SST Heat Exchangers have common ports at both sides of the heat exchanger to accommodate the NTC Temperature Sensor or the Flow Sensor.

It is important to ensure that the NTC Temperature Sensor is positioned on the water entry side of the heat exchanger - see below.

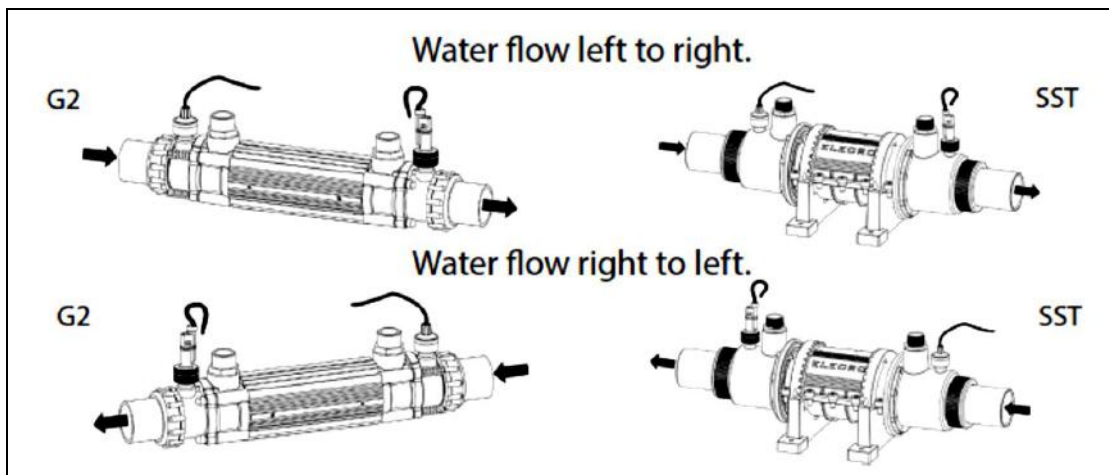

Fig 3.

2.2 Electrical connection

The Poolsmart Plus must be installed in accordance with the Country / regional requirements and regulations. In any event the work must be carried out by a qualified electrician who will provide a certificate of conformity upon completion of the work.

Undo the lower cover screws and remove the electrical access cover.

All electrical connections should be made into the relevant terminal block position, according to the labelled positions.

Connection Explanation:

- Terminal 1 = Incoming Live 100 to 230V
- Terminal 2 = Incoming Neutral
- Terminals 3 and 4 = Priority of Heating filtration pump override signal out
- Terminals 5 and 6 = Heat Out – Volt free switched output to control heating appliance (2-Amp MAX if the load is greater than 2-Amp an auxiliary contactor **must** be used)
- Terminals 7, 8 and 9 = RS485 MODBUS Data Link
- Terminals 10 and 11 = Flow Switch
- Terminals 12 and 13 = NTC Temperature sensing probe

See wiring diagram on page 7.

3. WIRING DIAGRAM

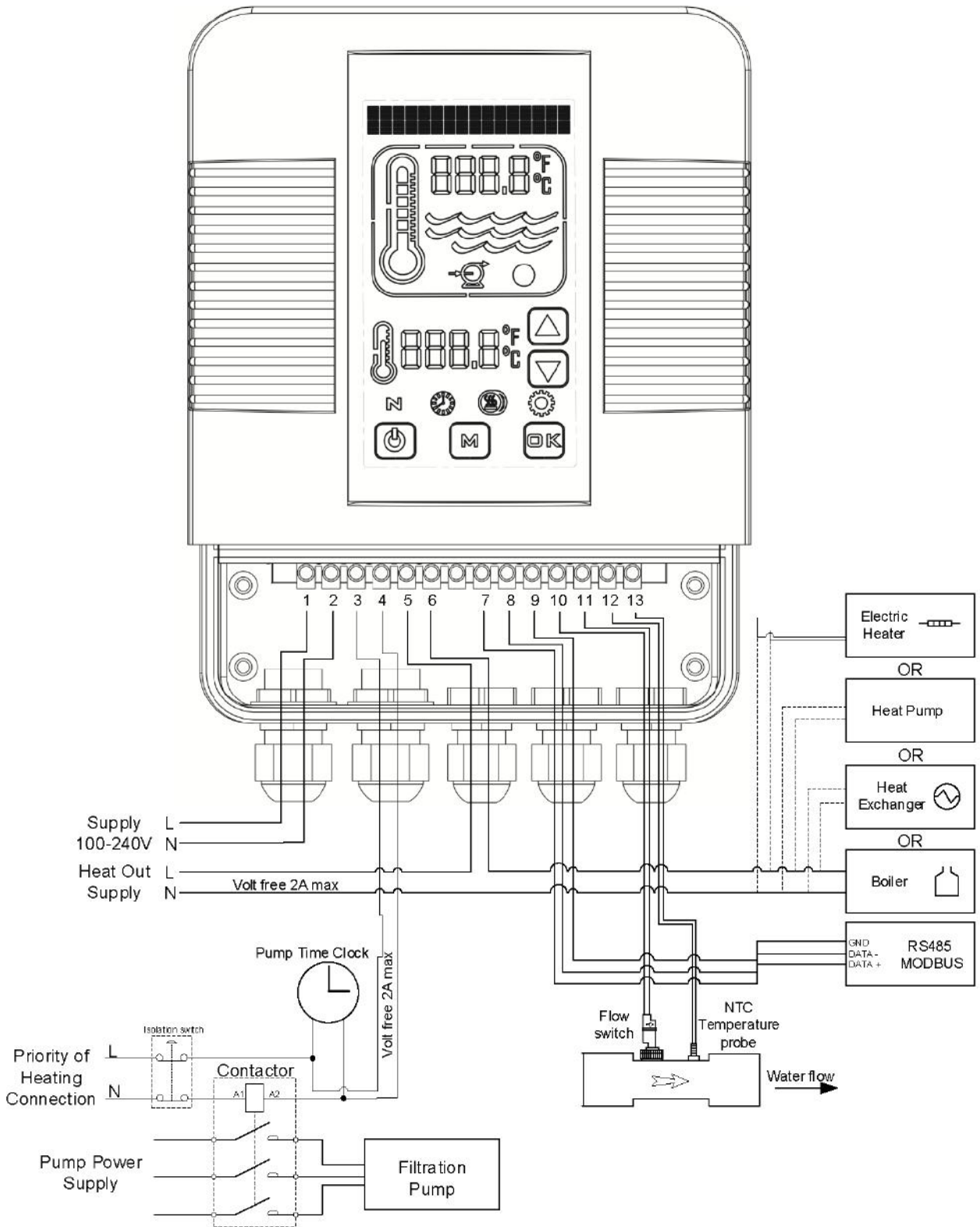

4. DIGITAL TOUCHSCREEN CONTROLLER OVERVIEW

The Touchscreen digital controller has been pre-programmed with all the necessary parameters to ensure reliable service & operation. Below is an overview indicating the controller button keys and graphical symbols.

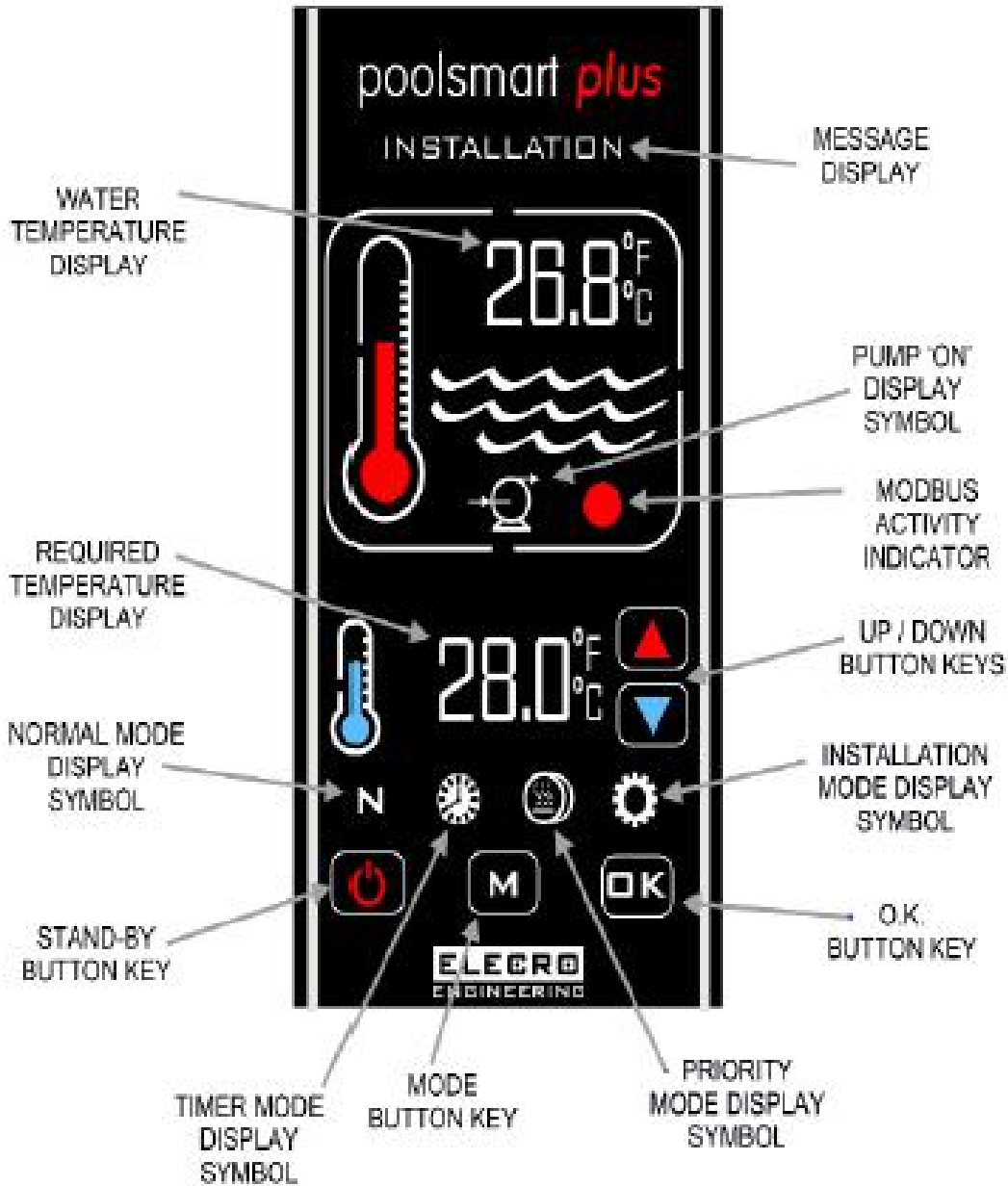

5. OPERATING INSTRUCTION

On initial power up of the controller the digital display will be illuminated.

The heating device will only be switched 'On' when the following criteria are met i.e.:

- Water circulating pump is 'On' delivering in excess of 4,000 litres per hour (4m³/h)
- The required temperature is set to a higher value than the actual water temperature

The digital display will show **'NORMAL'** and the graphical red coloured thermometer will be 'Animated' whenever the heating device is switched **'ON'**.



The actual pool water temperature is shown in the upper area of the display. The required temperature is shown in the lower area of the display. The required water temperature can be adjusted by touching the **'UP / DOWN'** touch button keys until the required temperature is displayed, adjustments are in 0.1°C increments.

Priority of Heating is a function that ensures your pool water is constantly maintained at your required temperature. When Priority of Heating is activated the Symbol  will be displayed on the screen.

The controller will then monitor the pool water temperature and start both the pool circulation pump and heating process when necessary.

Time Switching Delay

To prevent overheating of the switch components within the heating device caused by frequent on/ off switching (cycling) the controller has been pre-programmed with a time delay function.

When time switching delay is activated the message display will show **'HEATER DELAY'** for 2 minutes.

Differential

When the pool water has reached the required temperature the heating device will switch off and will not switch back on until the water temperature has fallen 0.6°C below the required temperature.

Operating Modes

There are five operating modes:

Normal



Timer



Priority



Installation



Standby



The required Modes are selected by touching the 'M' button key, each touch causes the mode to change to the next mode. The display will indicate which mode is currently selected together with the clock time.

(Example illustrated 'INSTALLATION' mode)



6. INSTALLATION MODE

When entering Installation mode, the heating device and pump will immediately be turned off (if they are on) and will not be permitted to be turned on while the controller remains in any of the setup menus. On exiting the 'Installation' mode the controller will revert to the 'Normal' mode and follow the same procedure as if first entering that mode, the display will reflect this.

- LANGUAGE (English, French, German, Spanish and Russian)
- UNITS (temperature units; centigrade or Fahrenheit)
- CLOCK (set current time)
- TIMER (four-time settings for switching the heating device 'On' and 'Off')
- PROBE CAL (Temperature calibration adjustment)
- MODBUS (Set Baud rate, address and parity for BMS connection)
- FACTORY (Access restricted)
- EXIT

6.1 Language Setup

Enter the 'INSTALLATION' mode by touching the 'M' button key repeatedly until 'INSTALLATION' appears at the top of the display then touch the 'O.K' button key.

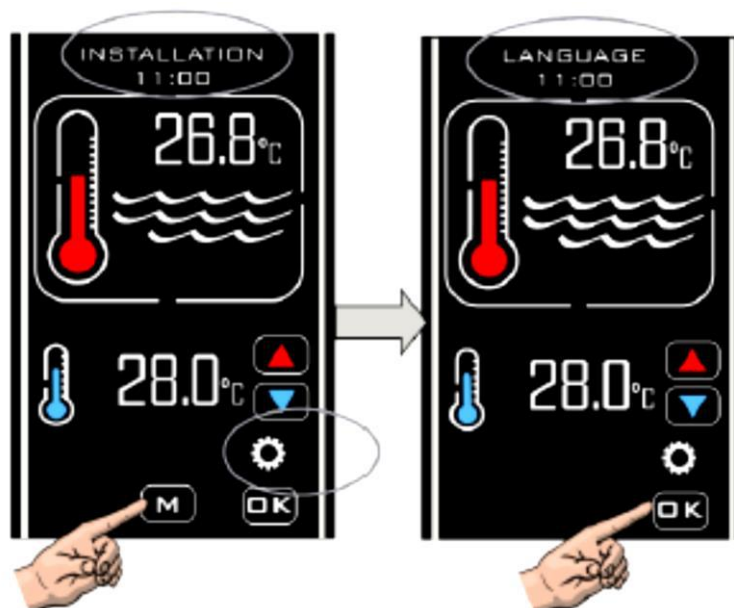

Touch the 'UP' / 'DOWN' button keys until the desired language is displayed then touch the 'O.K' button key to select

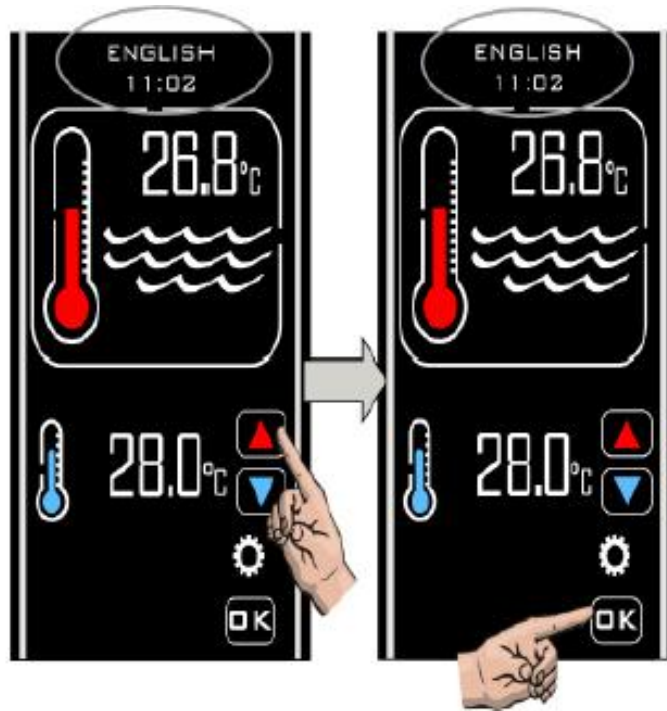

6.2 UNITS Setup

After selecting 'O.K'. For the language setup the display will then revert back to show 'LANGUAGE' touch the 'UP' / 'DOWN' button keys again to display the next option which is 'UNITS' touch the 'O.K' button key to select, the display will show 'UNITS' and 'CENTIGRADE' touch the 'UP' / 'DOWN' button keys to change to 'FAHRENHEIT' if required, touch the 'O.K' button key to select and save, the display will then revert back to 'UNITS'.

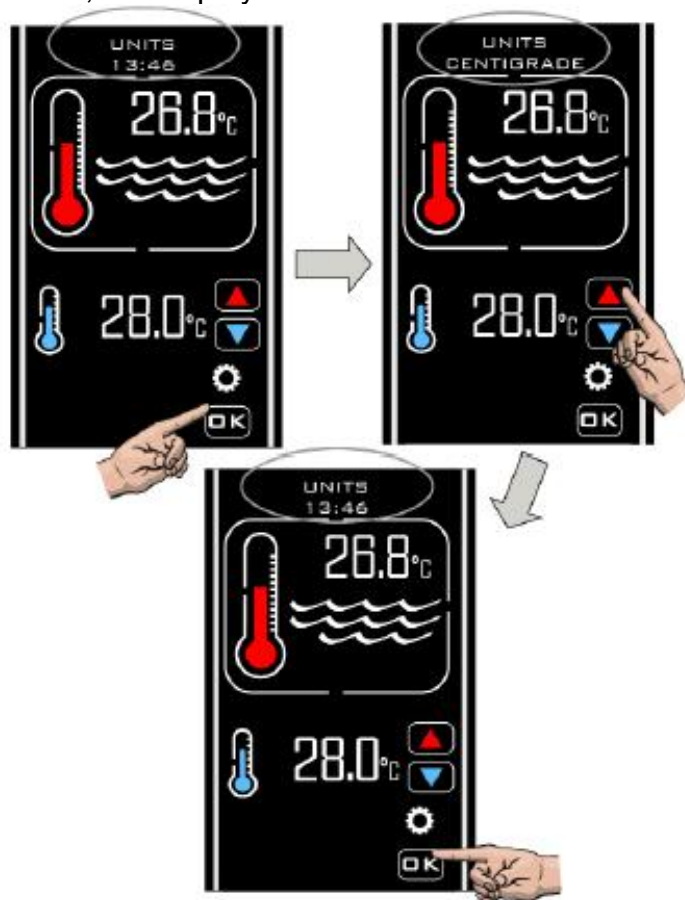

6.3 CLOCK Setup

Touch the 'UP' / 'DOWN' button keys to display the next option which is 'CLOCK' touch the 'O.K' button key to select, the display will show 'SET TIME' and the current clock time, touch the 'UP' / 'DOWN' button keys to change the clock time, touch the 'O.K' button key when the time is correct to save.

Note: The time can only be set in the 24-hour format.

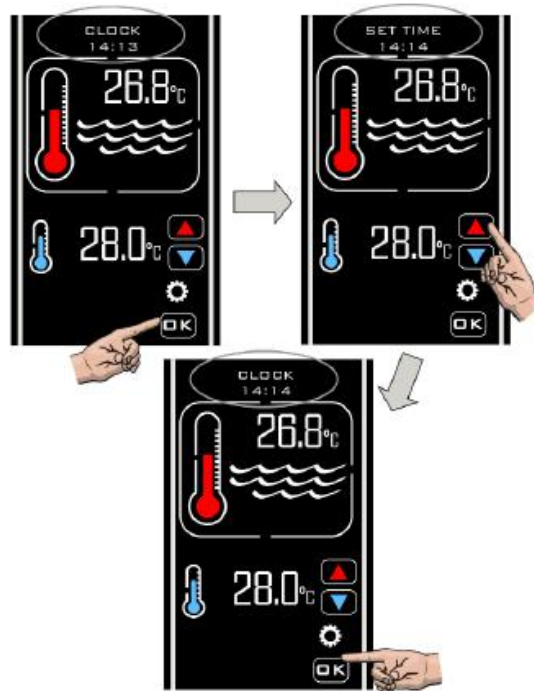

6.4 TIMER Setup

After selecting 'O.K' for the 'CLOCK' setup the display will then revert back to show 'CLOCK', touch the 'UP' / 'DOWN' button keys until 'TIMER' is displayed, touch the 'O.K' button key to select, 'TIMER 1' will be displayed, touch the 'O.K' button key to select and 'SET TIMER 1 ON' will be displayed, touch the 'UP' / 'DOWN' button keys to set the required time, touch the 'O.K' button key to save the setting, 'SET TIMER 1 OFF' will be displayed, touch the 'UP' / 'DOWN' button keys to set the required time, touch the 'O.K' button key to save the required time, the display will then show

'TIMER 2' repeat the same procedure for all four 'ON' / 'OFF' timer settings, select 'EXIT'. If any Timers are not required set the 'ON / OFF' times the same.

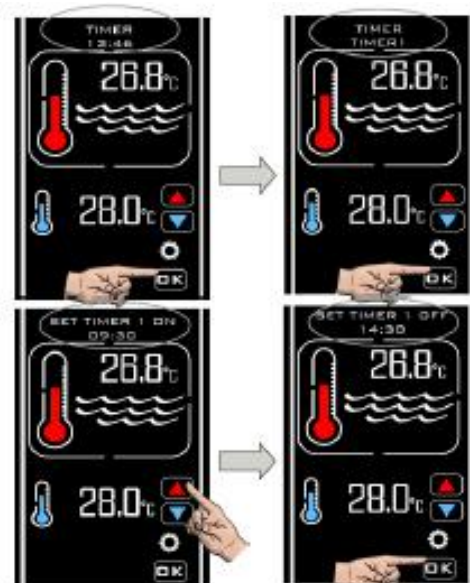

The timer mode allows you to set up 4 on and off time periods when you would like heating to take place. These can be set to take advantage of off-peak energy tariffs, or to ensure your pool is at the required temperature during specific time periods.

The controller allows you to override the time clock at any point by activating the Priority of Heating Mode explained on page 16.

Note: The time clock will only control the heating time periods and not the filtration pump cycles.

6.5 Probe Calibration Setup

After selecting 'EXIT' for the timer setup the display will then show 'PROBE CAL' touch the 'O.K' button key to select, touch the 'UP' / 'DOWN' button keys to increase or decrease the temperature calibration adjustment, touch the 'O.K' button key to select, the display will then revert back to show 'PROBE CAL'.

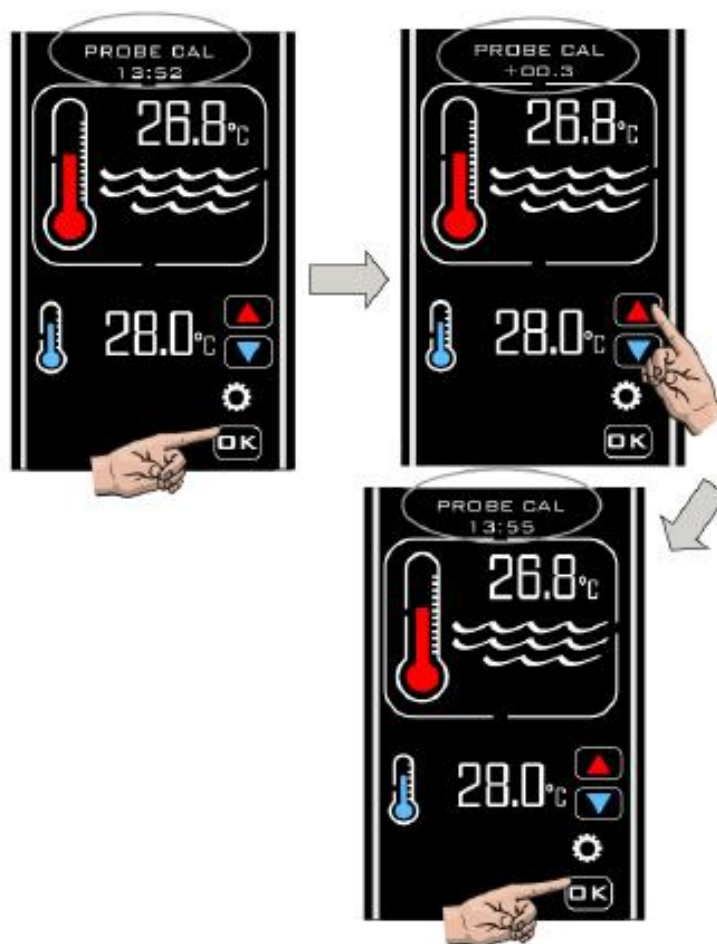

Probe calibration is usually not required. However, should you need to make an adjustment take a temperature reading from the pool water with an accurate thermometer then adjust as required.

Actual Water Temp	Poolsmart Plus Reading	Adjustment Required
28	30	-2.0
28	26	2.0

6.6 MODBUS Setup

Refer to your BMS Management System manual for the required settings. **SET BAUD** touch the **'O.K'** button key to select, **'MODBUS SET BAUD'** will be displayed, touch the **'O.K'** button key to select and **'SET BAUD 19200 Baud'** will be displayed, touch the **'UP'** / **'DOWN'** button keys for the other option **'SET BAUD 9600 Baud'** touch the **'O.K'** button key to select the required, Baud rate.

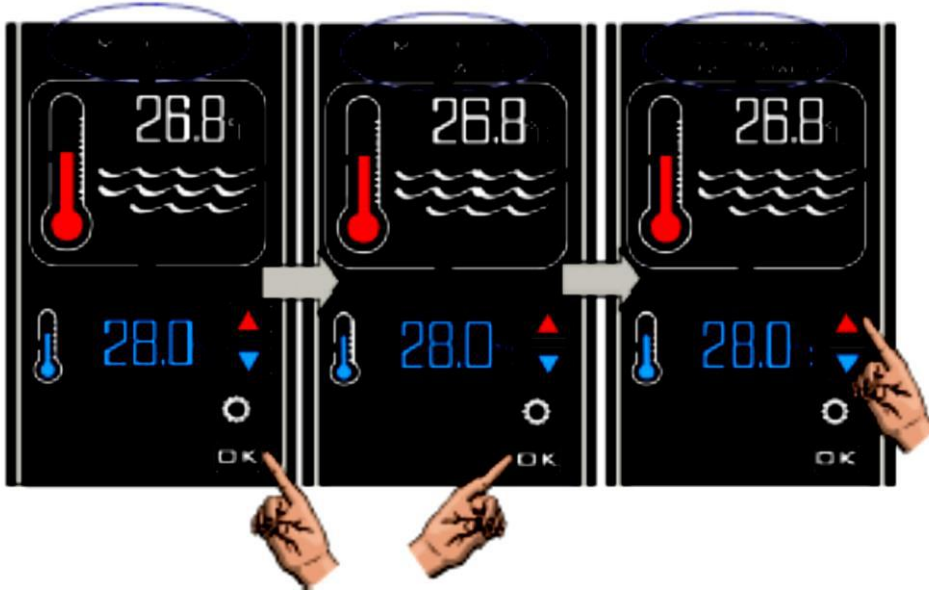

Set Address

Touch the **'UP'** button and **'MODBUS SET ADDRESS'** will be displayed, touch the **'UP'** / **'DOWN'** button keys to set the required address, touch the **'O.K'** button key, the display will revert back to show **'MODBUS SET ADDRESS'**.

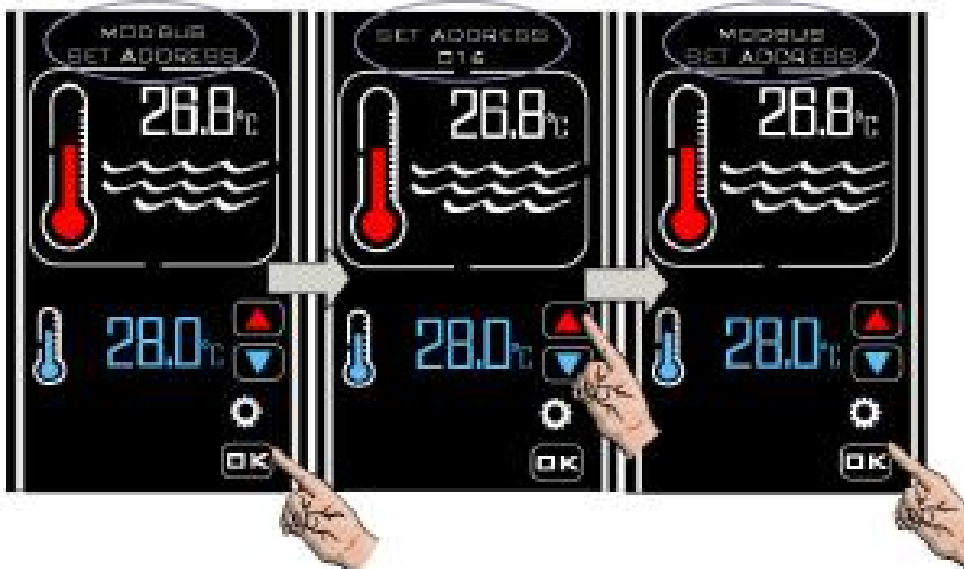

Set Parity

Touch the **'O.K'** button key to select **'MODBUS SET PARITY'** and **'PARITY ODD'** will be displayed touch the **'UP'** / **'DOWN'** button keys to change **'PARITY ODD'** to **'PARITY EVEN'** or **'PARITY NONE'** touch the **'O.K'** button key to select the required setting, the display will now revert back to show **'MODBUS SET PARITY'** touch the **'UP'** button key and **'MODBUS EXIT'** will be displayed, touch the **'O.K'** button key to select **'EXIT'** and the display will show **'MODBUS'**. Touch the **'UP'** button key and the display will show **'FACTORY'** touch again and **'EXIT'** will be displayed, touch **'O.K'** and the controller will exit the **'INSTALLATION'** mode and revert to **'NORMAL'** mode.

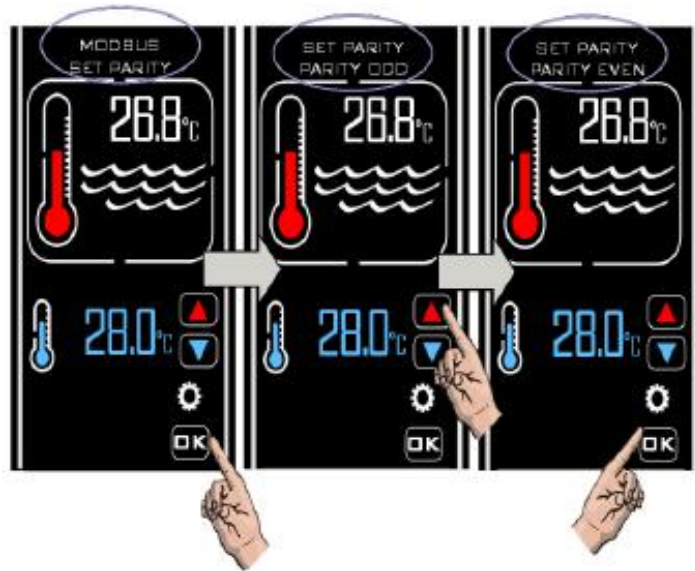

Once configured the **MODBUS** connection will enable the controller to be switched 'on' and 'off' (into and out of standby mode) remotely via an external BMS device.

6.7 FACTORY Setup

This category has restricted access.

7. OPERATING MODES

7.1 Standby Operating Mode

When in Standby mode the controller will display the text '**STANDBY**', Clock time and the Standby button key (as below).

When in this mode the internal clock continues to run but there is no other functionality apart from the Standby button key.

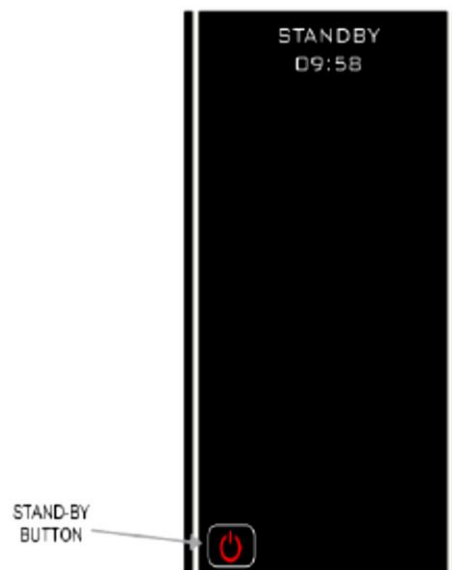

7.2 Normal Operating Mode

Under normal conditions when the controller is connected and 'On' and flow has been detected by the flow switch the controller display will be as shown below indicating the following information:

1. **'Normal'** and **'Time'**
2. Actual water temperature
3. Required temperature
4. If the Flow switch does not detect sufficient flow the message **'NO FLOW'** will be shown on the Display.

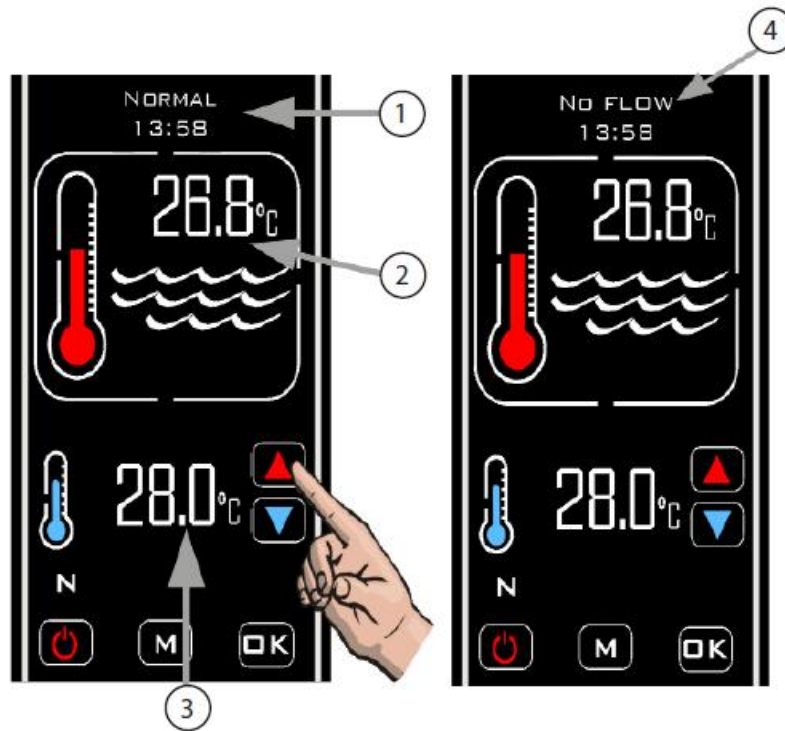

7.3 Timer Mode

To activate the Timer mode, touch the 'M' button key until the 'TIMER' symbol  is displayed (see below)



In this mode the controller will only heat during a timed-on period and when receiving sufficient flow.

If no or insufficient flow is being received no heating will take place. When in a timed off period no heating will take place.

7.4 Priority of Heating Mode

To activate the **'Priority of Heating'** mode touch the **'MODE'** button key until the **'PRIORITY'** symbol is displayed, the message **'FLOW STABILISING'** will be displayed, after two minutes the display will change to show **'SAMPLING'** and after a further two minutes the display will change back to **'PRIORITY'**.

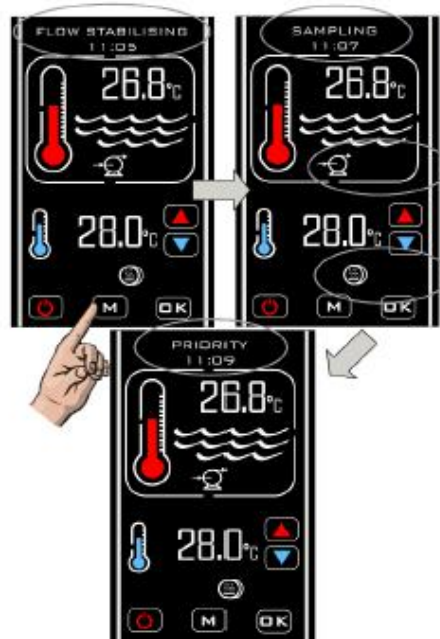



Once the **'Priority of Heating'** feature has been enabled the controller will take a water temperature sample every hour and the message **'SAMPLING'** will be displayed.

If the pool water temperature is below the required temperature, the controller will send a signal to the heating device to come on until the required temperature is reached. When the required temperature is reached the controller will switch the heating appliance off, followed by the filtration pump. **'Pump Delay'** will be displayed for one hour, then a new water temperature sample will be taken, if the sampled water is at or above the required temperature no heating will take place and the controller will switch the circulation pump off (pump delay will be displayed), then one hour later take a new temperature sample.

The sequence will continue to repeat until **'Priority of Heating'** is switched off.

7.5 Priority of Heating and Timer Mode

To activate the 'Priority' and 'Timer' modes together touch the 'M' button key until both symbols  and  are displayed.



In this mode the controller will heat whenever it is receiving flow during a timed-on period.

8. TROUBLE SHOOTING

Heating Device will not switch on

In most cases this will be the result of one of the following not being met:

Possible Cause 1. The required temperature has been reached.

To confirm the controller is requesting the heating device to switch on check that the required temperature is at least 0.6°C greater than the current water temperature and that the red thermometer in the display is 'animated' showing the thermometer increasing.

Possible Cause 2. Insufficient Flow.

The display will show 'NO FLOW' if the flow switch has detected that the flow volume is below 4,000-litres per hour (4m³/h).

Check that the flow volume is greater than 4,000-litres per hour and that the flow switch is in the correct orientation to sense flow (i.e. check that the arrow moulded into the flow switch body is facing in the same direction as the flow travelling through the T-Piece).

Possible Cause 3. The controller is in a timed off period.

Check if the controller has the 'TIMER' symbol  displayed – if it does check your clock and time period settings (explained in the set-up section).

Possible Cause 4. The heat output has not been correctly connected to the control circuit of your heating device.

Check the wiring diagram for verification on how the controller should be connected to the heating device and seek the expertise of a qualified electrician if in any doubt.

Possible Cause 5. The controller is in time delay mode.

If the display is showing '**HEATER DELAY**' the controller is in time delay mode.

This is activated if the controller is requesting the heating device to switch on more than once in a 2-minute period – this can be caused by a fluctuating flow rate (just above and then just below the 4,000-litre per hour requirement) or fluctuations in water temperature.

To rectify check the plumbing for any restrictions to flow and increase the flow volume. Also check the positioning of the temperature sensor, it should be positioned on the entry port of the heat exchanger.

9. DISPOSAL OF ELECTRICAL/ELECTRONIC EQUIPMENT

DO NOT dispose of this product as an unsorted municipal waste.

This symbol on the product or on the packaging indicates that this product should not be treated as household waste. Instead it should be handed over to the applicable collection point for the recycling of electrical and electronic equipment.



By ensuring this product is disposed of correctly you will help prevent potential negative consequences for the environment and human health, which could otherwise be caused by inappropriate waste handling of this product. The recycling of materials will help to conserve natural resources.



For more information please contact your local Civic Office, household waste disposal service or the retailer where the product was purchased.

10. WARRANTY

This product is guaranteed from the date of purchase against faulty workmanship and materials for:

- **two years within Europe**
- **one year outside Europe**
- The manufacturer will replace or repair, at its discretion, any faulty units or components returned to the Company for inspection.
- Proof of purchase may be required.
- The manufacturer will not be liable in cases of incorrect installation of the product, inappropriate use or neglect.
- Any damages occurred due to shipping must be reported within 48 hours of receipt of the product. Any claims after this time will be considered as misuse or abuse of the product and will not be covered by the warranty.
- The guarantee does not include serviceable parts, i.e. lamps, quartz sleeves and O-rings, etc.

**Electro Engineering Ltd
Repairs Department
Unit 11 Gunnels Wood Park
Gunnels Wood Road
Stevenage
Hertfordshire SG1 2BH
United Kingdom**

Customer Information: (ATTACH TO THE PRODUCT)

Company Name:

Contact Name:

**Daytime Telephone
Number:**

Email Address:

.....

Return Address:

.....

Post/Zip Code:

Country:

Suspect Fault / Description of problem:



Unit 11, Gunnels Wood Park, Stevenage, Herts SG1 2BH
Sales@elecro.co.uk www.elecro.co.uk +44 (0) 1438 749474

© Copyright MANE152-EN-Poolsmart Manual V1-01.01.2020-Elecro